



ALPHATRON
Marine



AlphaRiverPilot MFS

User Manual

www.alphatronmarine.com

Contents

I. Preface	4
Revision History	5
Glossary	6
Abbreviations	6
Definitions	7
II. Safety Information	9
III. Warranty	10
IV. About the manual	11
Intended readers	11
Manual overview	11
1 Introduction	12
2 AlphaRiverPilot MFS Control Unit	13
3 Operating modes	17
3.1 Introduction	17
3.2 STANDBY	19
3.3 MANUAL (FU/WEG)	19
3.4 AUTO	20
3.4.1 Rudder	20
3.4.2 Trim	21
3.4.3 Damping	21
3.4.4 Sensitivity	21
3.5 COMPASS	22
3.5.1 COMPASS ONLY	22
3.6 TRACK	23
3.7 Switching between more than 3 modes	24
3.8 SLAVE	24
3.9 Profiles	25
3.10 Inactive MFS Tiller	25
3.11 Adaptive Pilot	26
3.12 Take-over contact (mode blocking)	26



4	Controls and functions	27
4.1	Turn on	27
4.2	Turn off.....	27
4.3	Dimming	27
4.4	Alert handling	28
5	Menus.....	31
5.1	Menu ‘Main Menu’	31
5.1.1	Ship Config	32
5.1.2	Adapt Mode	32
5.1.3	User Settings	33
5.1.3.1	Touch screen calibration	33
5.1.3.2	Display cleaning.....	34
5.1.3.3	Theme	34
5.1.3.4	Date Time	35
5.1.3.5	About.....	36
5.1.3.6	Lock Screen	37
5.1.4	Adv Set	38
5.1.5	Remote Access	38
5.1.6	Pilot Set	38
	Appendices	39
	Appendix A: Specification - AlphaRiverPilot MFS.....	40
	Appendix B: Mechanical drawings - AlphaRiverPilot MFS	41
	Appendix C: AlphaRiverPilot MFS Mode buttons + Profile name table	43
	Appendix D: Alpatron MFS Alerts	44

I. Preface

The Alpatron AlphaRiverPilot MFS is a ES-TRIN approved Autopilot System, designed to fit vessels of any size, including high speed crafts. It is a modern and technologically advanced digital vessel control unit that is intended to reduce the operator's workload, increase the vessel motion efficiency and improve operational safety. The AlphaRiverPilot MFS Control Unit is used for control and monitoring of autopilot operation, setting vessel rudder angle or heading, and selection of autopilot operating modes.

The AlphaRiverPilot MFS, also identified as RPU MK4 by the manufacturer EBF, is the successor to the previous AlphaRiverPilot MF model, also known as MK3 or EBF02A that came out in 2004. We have kept the proven technology from its predecessors (MK1, MK2 and MK3) and extended on it. This new pilot has the possibility to operate fully digital.

The AlphaRiverPilot MFS system exists out of a processor box, a control unit and if applicable, a rudder feedback sensor. Backwards compatibility with analogue sensors is possible, but MK1, MK2, MC, Basic and BasicTriple tillers or processor boxes are not compatible with the new AlphaRiverPilot MFS.

- Thoroughly read this user manual before operating the equipment.
- We recommend keeping this manual nearby the equipment to ensure easy access to it.



Revision History

Revision No.	Date	Description	Author
1.0	10-01-2024	First issue	T. de Nooijer

Glossary

The glossary contains a list of abbreviations and a list of definitions.

Abbreviations

Abbreviations as used in this manual are explained in the table below.

Abbreviation	Description
AIS	Automatic Identification Systems
AUTO	Automatic ('ROT Control mode')
COG	Course over ground
ECDIS	Electronic Chart Display and Information System
FU	Follow-Up
GNSS	Global Navigation Satellite System
GPS	Global Positioning System
HSC	High Speed Craft
HMS	Heading Monitor System
IMO	International Maritime Organization
MK	Mark
NFU	Non-Follow-Up
PID	Proportional, Integral, Derivative
PS	Port Side
RAD	Radius
RFB	Rudder Feedback Unit
ROT	Rate Of Turn
RPU	River Pilot Unit
SB	Starboard Side
SOG	Speed over ground
STBD	Starboard
TCA	Track Control Assistent
Track	TrackPilot

Definitions

The meaning of standard definitions as used in this manual are explained in the table below.

Definition	Description
Alert	Announcement of abnormal situations and conditions requiring attention. Alerts are divided in two priorities: alarms and warnings: <ul style="list-style-type: none"> - Alarm: An alarm is a high-priority alert. Condition <u>requiring immediate attention and action</u> by the captain, to maintain the safe navigation of the ship. - Warning: Condition <u>requiring immediate attention, but no immediate action</u> by the captain. Warnings are presented for precautionary reasons to make the captain aware of changed conditions which are not immediately hazardous, but may become so if no action is taken
AlphaRiverPilot MFS	Alphatron brand name for the autopilot system
Autopilot	Autopilot is the use of an automatic system to control the rudder on the vessel. Use of autopilot can reduce the fuel consumption by smoothing out the large angle rudder movements used to hold a steady course.
COG (Course Over Ground)	COG is the actual direction of progress of a vessel, between two points, with respect to the surface of the earth. The vessel's heading may differ from the COG because of wind, tide and currents.
Course	A vessel's course is the cardinal direction along which the vessel is to be steered. It is to be distinguished from the vessel's heading, which is the compass direction in which the craft's bow is pointed.
Cross track distance	Perpendicular distance of the vessel from the track including direction (negative if the vessel is left of the intended track)
ECDIS (Electronic Chart Display and Information System)	A geographic information system used for nautical navigation that complies with IMO regulations as an alternative to paper nautical charts. An ECDIS displays the information from ENC or DNC and integrates position information from position, heading and speed through water reference systems and optionally other navigational sensors.
Electronic Navigational Charts	An official database created by a national hydrographic office for use with an ECDIS.
Heading	The horizontal direction in which a vessel points or heads at any instant, expressed in angular units from a reference direction, usually from 000° at the reference direction clockwise through 360°.
Heading control	Control of the vessel's heading.
IEC	A non-profit, non-governmental international standards organization that prepares and publishes International Standards for all electrical, electronic and related technologies.
Indication	Visual display of any message to the user which may be accompanied by a low intensity acoustic signal to gain attention.
Latitude and Longitude	The units that represent the coordinates at geographic coordinate system.

Definition	Description
Main steering gear	The machinery, rudder actuators, steering gear power units, if any, and ancillary equipment and the means of applying torque to the rudder stock (e.g. tiller or quadrant) necessary for effecting movement of the rudder for steering the vessel under normal service conditions.
Magnetic compass	The Earth has a magnetic field which is approximately aligned with its axis of rotation. A magnetic compass is a device that uses this field to determine the cardinal directions.
Manual (steering) mode	Method of controlling steering gear manually is contrast with automatic steering control mode (course control mode). Both Follow-Up and Non-Follow-Up modes may be considered as manual steering mode.
Rate-Of-Turn	The speed (or rate) at which a vessel is turning at, or can turn at, measured in degrees per minute.
Relative bearing	The direction of a target from own vessel expressed as an angular displacement from own vessel's heading.
Relative course	The direction of motion of a target relative to own vessel's position expressed as an angular displacement from north. It is deduced from several measurements of target range and bearing on own vessel's radar.
Relative speed	The speed of a target relative to own vessel's position. It is deduced from several measurements of target range and bearing on own vessel's radar.
River Pilot Unit MK4	Manufacturer EBF brand name for the processor box mark 4
Rudder Feedback Unit	The Rudder Feedback Unit can be used in a rudder angle indicator system and as a part of the control loop in a steering control system.
Speed	The absolute value of velocity. May either be the vessel's speed through the water, or the speed made good over the ground.
SOG (Speed over ground)	The speed of the vessel relative to the surface of the earth.
Steering gear	The equipment provided on vessels to turn the vessel.
Tiller	A device that is used to turn for example, the rudders or propellers, which then steers the boat.
Track	Path to be followed.
Waypoint	An intermediate point or place on a route or line of travel, a stopping point or point at which course is changed.

II. Safety Information

The signal words DANGER, WARNING and CAUTION used in this manual indicate the degree of hazard that may be encountered by the user. These words are defined as follows:

**DANGER**

Indicates a hazardous situation which, if not avoided, will result in death or serious injury. This signal word is limited to the most extreme situations.

**WARNING**

Indicates a hazardous situation which, if not avoided, could result in death or serious injury.

**CAUTION**

Indicates a hazardous situation which, if not avoided, could result in minor or moderate injury.

The signal word NOTICE used in this manual indicates information considered important but not related to injury. It is typically used to prevent damage to equipment or property.

To safely operate this system, the following DANGERS, WARNINGS, and CAUTIONS must be adhered to. Failure to comply with the precautions or with specific dangers, warnings, and cautions elsewhere in this manual violates safety standards of design, manufacture, and intended use of the equipment. ALPHATRON MARINE assumes no liability for the customer's failure to comply with these requirements.

**WARNING**

When the AlphaRiverPilot MFS is not used for longer periods of time, we recommend turning the MFS control units off to save screen time, prolonging it's life cycle. Bootup time is within 10 seconds.

**WARNING**

Immediately turn off the power and disconnect the power supply cable if the equipment is generating any smoke or odour or is overheated. Immediately inform your local service agent of the symptom to have it repaired. Prolonged equipment operation under such a condition can cause a fire or electric shock.

**WARNING**

Do not disassemble or modify the equipment. Otherwise, it may cause a fire, or you may suffer an electrical shock.

**WARNING**

Do not place a vessel containing liquid on the equipment. Otherwise, it may cause a fire, or you may suffer an electrical shock if knocked over.



III. Warranty

To not to adversely affect the warranty, the following notices must be adhered to.

NOTICE Operating personnel must not remove equipment covers. Only personnel trained and certified by ALPHATRON MARINE must make component replacement and internal adjustment.

NOTICE Non-compliance with the installation, operation and maintenance requirements may void the warranty.

NOTICE Do not disassemble or modify the equipment. Failure to observe this instruction may cause equipment failure, and it will void the warranty.

NOTICE Any modification to this equipment without prior written permission from ALPHATRON MARINE will void the warranty.

NOTICE Installation of this product shall only be done by a certified installation company approved by either ALPHATRON MARINE or by an official ALPHATRON MARINE distributor. Acting otherwise will void the warranty.

NOTICE This product contains no operator serviceable parts. Service and repair shall only be carried out by personnel trained and certified by ALPHATRON MARINE.

NOTICE Do not place a vessel containing liquid on the equipment. The equipment can be damaged if knocked over.

NOTICE When cleaning the surface, do not use any organic solvent such as thinner or benzine. Otherwise, the paint and markings on the surface may get damaged. For cleaning the surface, remove the dust and debris and wipe with a clean dry cloth.

Contact the official Alpatron Marine distributor regarding the terms of the warranty.

IV. About the manual

Intended readers

This manual is an operation manual for the AlphaRiverPilot MFS system. The manual is intended for users operating the system, and to inform crew personnel.

Manual overview

This manual has the following chapters:

- **Introduction** contains a description of the AlphaRiverPilot MFS system.
- **AlphaRiverPilot MFS Control Unit** contains a description of the Control Unit and its interface.
- **Operating modes** contains a description of the autopilot operating modes.
- **Controls and functions** contains a description of the basic functions such as dimming, alert handling.
- **Menu's** contains a description of the accessible menus and menu items.
- **Alarms and warnings** contains a description of alerts displayed on the MFS control unit.

1 Introduction

All Alpatron Marine Autopilots meet the rigorous and diverse demands of commercial applications from pushboats, tugs, tankers, cruise ships and many other river going, gyro based vessels.

Accordingly, the Alpatron AlphaRiverPilot MFS system is a ES-TRIN Approved Autopilot System equipped with manually adjustable PID control facilities and an Adaptive mode to provide optimum steering performance in all operating conditions.

In addition to the PID intelligence inherent in the Alpatron AlphaRiverPilot MFS system, 'Rate of Turn to Steer' data can also be accepted from an approved Track Control System to provide automatic set/drift compensation or to perform complex route manoeuvres based on multiple way point route programming.

The AlphaRiverPilot MFS Control Unit works in conjunction with the AlphaRiverPilot MFS Processor Box, which connect to the steering system or to the steering gear.



Figure 1: AlphaRiverPilot MFS Processorbox MK4 (RPU)

2 AlphaRiverPilot MFS Control Unit

The Alpatron AlphaRiverPilot Control Unit has a touch screen display, 3 buttons at the top, 180 degrees tiller handle, and a ON/OFF button.

The touch screen display and buttons show information such as the mode, profile, setpoint, feedback, steering direction, settings and alerts.

The 180 degrees tiller is used for manual steering of the vessel.

The ON/OFF button is used to turn the MFS Control Unit off or on. The processor box is always on.



Figure 2: AlphaRiverPilot MFS Control Unit

All information, menus and functions are shown in English by default, but Dutch and German language can be selected in the MFS menu.



Number	Description
1	<p><i>Text in the 3 buttons depend on configurations and chosen language.</i></p> <p>The text "MAN" can be replaced by "FAST" mode, this mode is used to show a second pump is enabled for faster rudder movement.</p>
2	<p>Currently on AUTO mode (indicated with green selection). A mode can be selected by pressing the white text. User need to press for a minimum of 0.2 seconds and an maximum of 2 seconds. An audible beep is heard.</p>
3	<p><u>If more modes are enabled (for example MAN, AUTO, TRACK & COMP),</u> holding this button down longer than 2 seconds, an initial beep will be heard, followed by 2 short beeps. After the selection menu will show up. Here you can select another mode. (The text in button 3 will change automatically to this new mode)</p> <p><i>This menu will close by itself if no mode is selected after some seconds.</i></p>
4	<p>Alarm/warning indication/button</p> <p>When alarm/warning is present, the user can press this button to display and acknowledge the different alarms/warnings.</p> <p><i>When pressing the alarm/warning information bar below, the sound can be muted.</i></p>
5	<p>Indicates the selected profile.</p> <p>-15.5 °/min indicates the degrees per minute. Negative value is portside and positive is starboard</p> <p>Red and green arrow next to the degrees indicate valve steering, red = Portside and green = Starboard.</p> <p>Rudders/Propellers can be configured to:</p> <p>ASYM = asymmetrical</p> <p>SYM = symmetrical</p>
6	<p>Yellow Rate of Turn feedback graph bar 30/90/300 degrees. (Different per mode)</p> <p>Yellow bar indicates the real time value of the (ROT) sensor.</p> <p>The small red arrow above the bar indicates the position of the tiller and has the same value as the -15.5 degrees shown above.</p>
7	<p>DIM + and DIM -</p> <p>Is used for dimming the screen and also the light for the ON/OFF button.</p> <p>It can also dim other Alphasatron devices if connected</p>
8	<p>RUDDER, TRIM, DAMPING, SENS. (sensitivity)</p> <p>4 buttons with built-in bars to indicate what the active value is. Pressing these buttons activates a pop-up menu to change the settings. The menu will automatically disappear after 10s.</p> <p>User need to press for a minimum of 0.2 seconds and an maximum of 2 seconds. An audible beep is heard.</p>
9	<p>Locking icon, indicates if touchscreen is locked or not. holding this button down longer than 2 seconds, an initial beep will be heard, followed by 2 short beeps. Message shown: UNLOCKED or LOCKED.</p> <p>In this state, the lock is off. When the lock is on, the whole screen <u>except</u> the three mode buttons at the top are blocked.</p>

10	<p>MENU</p> <p>Button to enter the menu options. If nothing is done in the user menu, the normal screen will return after 60 seconds. Service menu always stays open.</p>
11	<p>Green ON indication. Always visible when the pilot is turned on.</p>
12	<p>ON/OFF button. Like other MF products, this button shuts the MFS device down after 2 seconds.</p> <p><i>Note: a hard push is required to activate.</i></p>
13	<p>Tiller unit. This unit is built on top of the MFS. Calibration can only be done on the MFS in the service menu.</p>
14	<p>ADAPTIVE MODE indication, only shown if mode is on. Can be dis/enabled in the menu.</p> <p>When this mode is active, the pilot will automatically adjust the settings. For example, if more rudder is needed to achieve a curve, the pilot will automatically increase this setting.</p>

Table 1: Description of AlphaRiverPilot MFS displayed information

3 Operating modes

3.1 Introduction

The AlphaRiverPilot MFS system is comprehensively equipped with alarm mechanisms that continuously monitor the operational integrity of a wide range of functions from gyro input data to steering gear response.

Alarms and warnings are displayed on the AlphaRiverPilot MFS Control Unit. An Alert symbol will be shown, accompanied with or without an audible signal (see Chapter 4.4).

The alert messages listed Appendix D: Alphatron MFS Alerts will be displayed (if appropriate) and will be accompanied by the appropriate Alert symbol. Alerts are acknowledged by pressing the Alert indicator.

The operating modes are displayed in the buttons on the AlphaRiverPilot MFS Control Unit and are explained in this section. Colored text is used to clearly indicate the active autopilot operating mode.

To choose a different mode, press the non-green **MODE** button to change the control mode (the color of the text will turn green). When the desired mode text is green, the Autopilot goes into the selected mode (the respective operating screen will be shown on the display).

Note: depending on settings, the user can click the green text mode button again, to switch to standby (indicated on the screen and no text modes are green). It is also possible to choose from more than 3 modes, these can be chosen on the third mode button by pressing and holding down the button.

A list of all available modes:

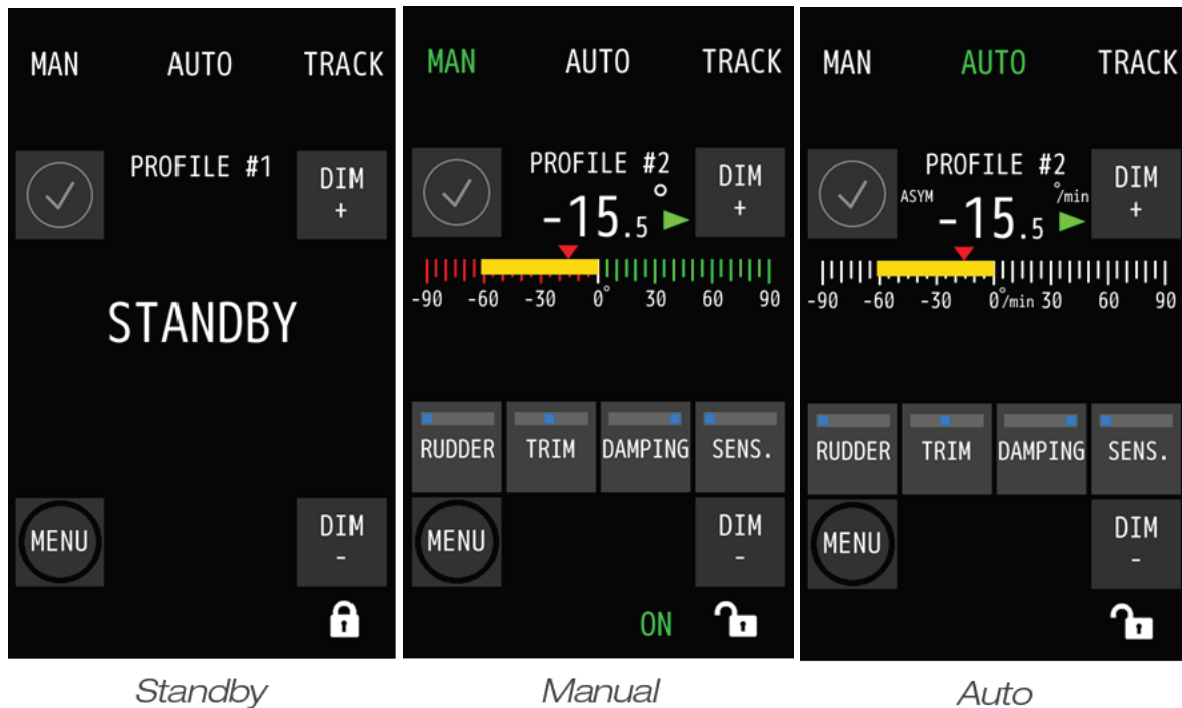



Compass

Track

Slave

STANDBY	Standby mode. The AlphaRiverPilot does not steer.
MANUAL (Follow Up)	The vessel can be hand steered using the tiller. Hand steering is typically used when the vessel is maneuvering, and navigating in restricted waters, channels, and areas with traffic density.
AUTO	The Pilot steers the vessel to the asked tiller position shown on the MFS Tiller Unit and will try to keep the ship on this course with the help of the gyrotol sensor.
COMPASS	The Pilot will steer the ship towards the set course displayed on the screen. by moving the tiller out of the zero position, a new heading is calculated onscreen and only when putting the tiller back to zero, is the new heading accepted.
COMPASS ONLY	Same as Compass mode, but in this mode the gyrotol sensor is not used. this way the rudder will not counteract as much for situations when the ship is undergoing too much movement. i.e. big waves, open waters, etc.
TRACK	The controls of moving a track line and displaying info are now integrated into the MFS display. This allows for ergonomic installations and ease of use.
SLAVE	In this mode, the Pilot is a slave to the master pilot and follows the green MFS Control unit commands.

*Note: the MFS Control Unit is only in control when the corresponding mode text is colored **green!** When the text is **blue**, this mean the tiller is not in control and only shows information!*

3.2 STANDBY

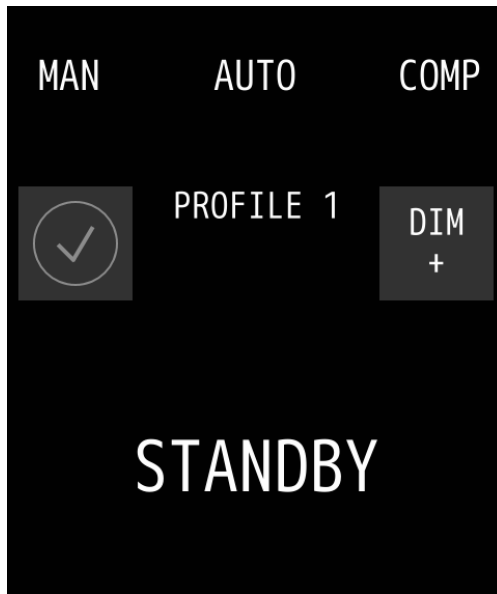

The standby mode can be triggered in two ways:

- By an external contact/switch/button connected to the pilot. Often this is an integrated contact from the main steering gear.
- By the user. This screen can be activated by pressing the mode again that is already selected green. So when AUTO is selected, selecting it again would turn the pilot to standby mode. This option is disabled by default.

When the MFS is in standby mode by user interaction, the user can get out of standby, by pressing a mode.

When the pilot is in standby mode via an external switch, the pilot can only get out of the standby mode via an external contact/switch! Not via the MFS unit. Even when the pilot is shut down and powered up again, it will go to

the standby screen if the external contact/switch is active. After the contact/switch is turned off, the user can exit the standby mode.

When pressing a mode button while external switch is enabled, 3 short beeps are heard, indicating the pilot is blocked and cannot be operated.

3.3 MANUAL (FU/WEG)

Follow Up/Manual mode or well known as the mode WEG.

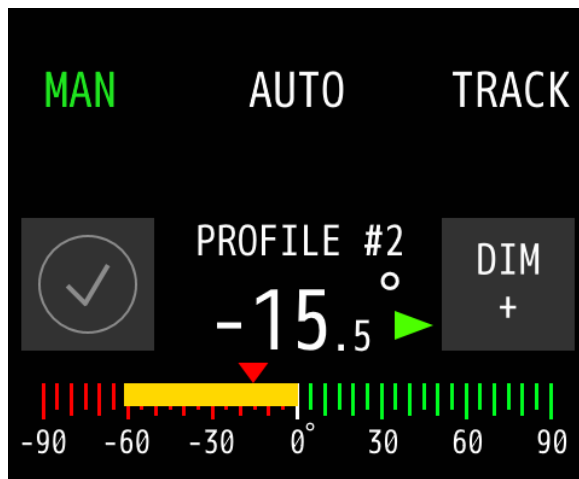

- Red/green rudder feedback bar with 90 degrees scaling.
- Yellow bar indicates the real time position of the rudder. Scaling Portside is red and starboard is green.
- The small red arrow above the bar indicates the current position of the tiller.

The endpoints of the rudder/tiller and possible TRIM setting are set during installation.

Note: it is also possible to switch from MAN to FAST mode. The FAST mode text is a visual indication

that can be used in conjunction with an additional pump that increases the rudder speed onboard the vessel. For more information, please contact Alpatron Marine Inland department.



3.4 AUTO

The well-known Auto mode, or Autopilot.

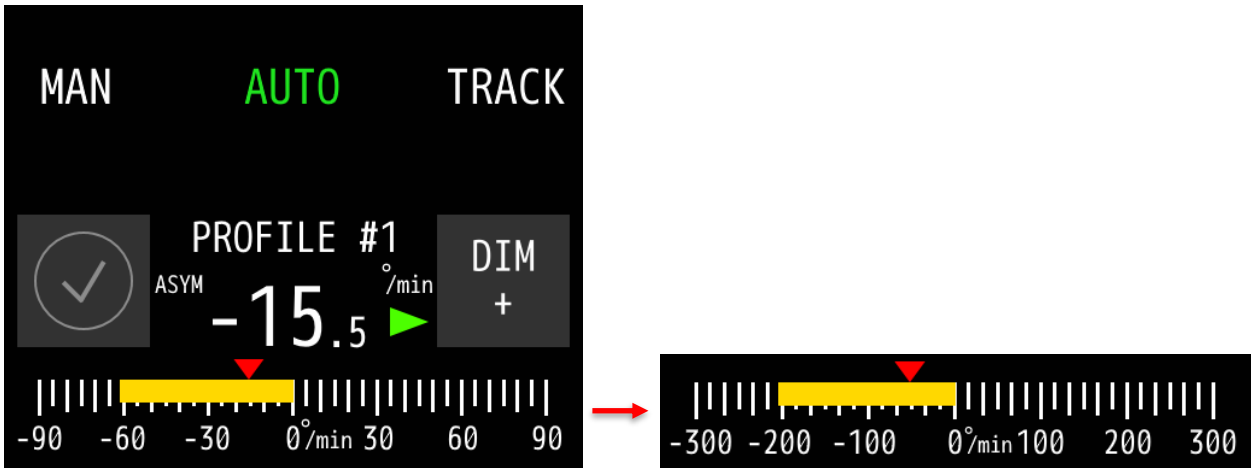

- Rate of Turn feedback graph bar with 30, 90, or 300 degrees scaling.
- Yellow bar indicates the real time position of the rate of turn sensor (gyrotol)
- The small red arrow above the bar indicates the current position of the tiller.

The maximum amount of rate of turn allowed on the autopilot is set during installation.

3.4.1 Rudder

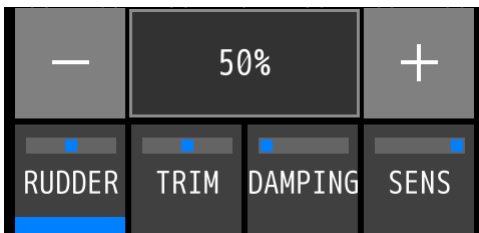

This setting can be changed by the user to in- or decrease the amount of rudder the autopilot will use. This includes the amount of counter-rudder. 50% is the middle settings, with 2% as its minimum and 100% for the maximum. Allowing the user to freely adjust a certain amount of rudder.

Rudder is often different depending on the ship's cargo, depth and the speed at which the ship is sailing at. When the ship is empty for example, less rudder is required to stay on its trajectory and when the ship is fully loaded, more rudder is required.

To change the value, the user must first select the Rudder button by long-pressing it. Then the user can tap the plus or minus buttons that appear for 1% steps. Hold the button down to make steps of 10%. The setting will automatically disappear.

3.4.2 Trim

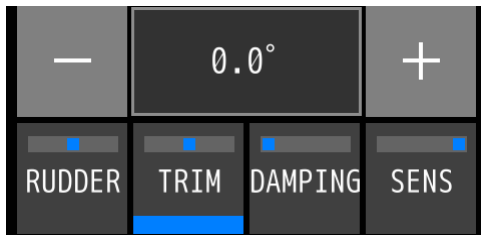

The trim setting is used for when the ship is not sailing straight. When the ship seems to be continuously return to this offset, trim can be used to put the ship onto a straight trajectory again. A maximum of 10 degrees for both portside and starboard is allowed. Normally only auto modes can use this setting, but a trim is also available in Manual mode if setup during installation.

To change the value, the user must first select the Trim button by long-pressing it. Then the user can tap the plus or minus buttons that appear for 0.1 degree steps. Hold the button down to make bigger steps of 1 degrees. The setting will automatically disappear.

3.4.3 Damping

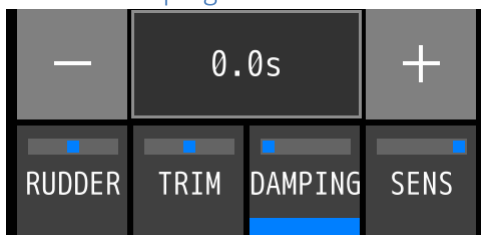

Damping is used to “dampen” the gyrotol sensor signal. Adding a time delay on the reaction speed of the autopilot. In normal weather operation, this setting should remain 0.0s. Only in situations where the ship is heavily influenced by outside conditions and the autopilot is working to counteract these changes, resulting in too many rudder movements, damping is wished for. Max damping is 5 seconds.

To change the value, the user must first select the Damping button by long-pressing it. Then the user can tap the plus or minus buttons that appear for 0.1 second steps. Hold the button down to make bigger steps of 1 second. The setting will automatically disappear.

3.4.4 Sensitivity

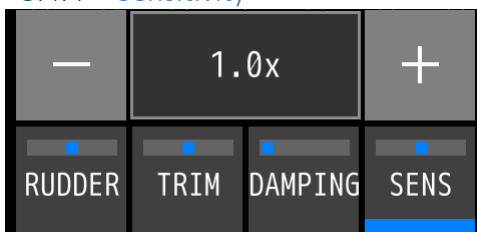

Sensitivity, or Sens in short, allows the user to change the response speed of the rudder movement. Normally left at 1.0x setting, which is the same behavior as in Manual mode. if lowered, the rudder will become slower and if put higher, the rudder will move faster, but the chance of overshooting is present. The use of this setting depends on the situation of where the ship is sailing. In the canal for example, a quicker

rudder movement might be wished for with the same rudder setting because of low water or because of sailing close to the riverbank. Minimum is 0.2x and maximum is 2.0x rudder speed.

To change the value, the user must first select the Sensitivity button by long-pressing it. Then the user can tap the plus or minus buttons that appear for 0.1x steps. Hold the button down to make bigger steps of 1.0x steps. The setting will automatically disappear.

3.5 COMPASS

The 4 digits displayed in degrees shows the setpoint that can be set with the tiller or the four arrow buttons that can be accessed by long-pressing the control button, left of the DIM – button.



The small arrow buttons allow for finetuning with 0.1 degree steps. The big arrow buttons make steps of 1 degrees. When holding the big arrow buttons for more than 2 seconds, bigger steps are made. No rounding of numbers is done. The entire scale of degrees can move on a horizontal axis and the position depends on the real-time value of the compass. The yellow bar in the middle is static and hovers over the real time value of the compass.

The red arrow above the bar indicates the setpoint. If the setpoint is not on the visible portion of the bar, then it is out of scope and is not drawn until it is back in a visible range.

The control button left of the DIM- button can be (de)selected to show or hide regular settings (RUDDER, TRIM, DAMPING and SENS.)

3.5.1 COMPASS ONLY

Another mode is accessible if setup during installation, that is the compass only mode. In this mode the autopilot will not use the installed gyro sensor onboard for correction in its trajectory. This could be wished for when the ship is sensitive to rough weather conditions and less rudder corrections is wished for. In essence the autopilot looks only at the compass value and calculates the needed rudder over a period of time, resulting in a less aggressive autopilot.

3.6 TRACK

The Trackpilot is now semi-integrated into the autopilot. Allowing the user to control the track line, readout information and receive alerts.

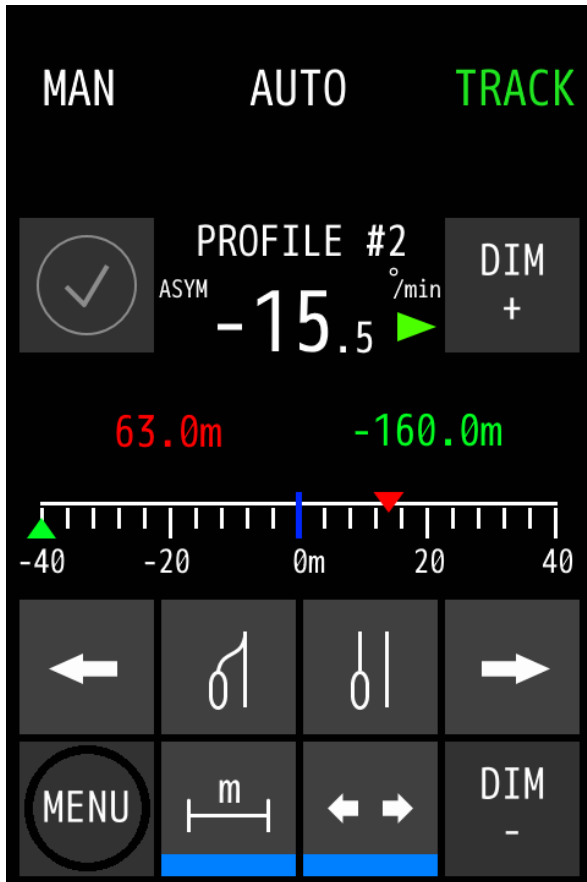

A scale in meters is shown for information about the current position of the ship in green and the offset to the original line in red. The original line is the static blue line in the middle of the scale. The scale can widen and crimp in size and depends on both the green and red arrows on top of the scale, ranges are:

- 160m
- 80m
- 40m

Middle left button marked with “m” next to the menu button is to switch between the Rate of Turn bar and track pilot setpoint and offset digits marked red and green respectively.

The control button left of the DIM- button is to switch between standard autopilot (RUDDER, TRIM, DAMPING, SENS) settings and track pilot buttons. When the button is active (blue line at the bottom of the buttons), it will show four track pilot buttons:

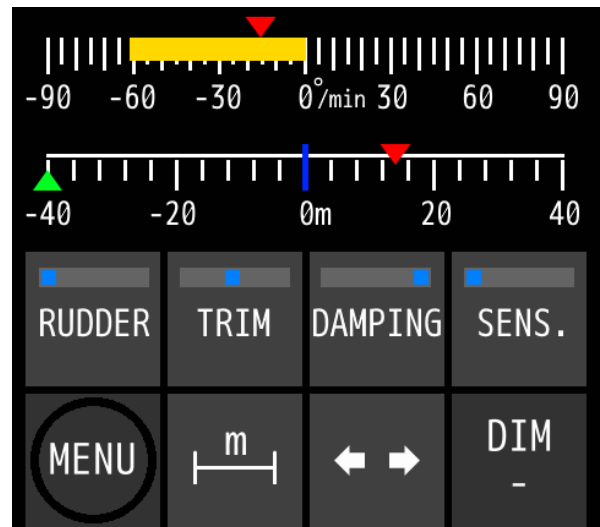

- left and right arrows will move the red line (offset to original line in blue). When holding down one of the arrow buttons, the offset value will increase incrementally, moving the line faster.
- The middle-right button of the control buttons will place the red arrow onto the green arrow, effectively telling the track pilot to keep the current offset from the original line and keep sailing with this offset. A.k.a. parallel sailing to the original track line.
- The middle-left button will remove the offset and put the red arrow onto the blue middle line. The original track line.

3.7 Switching between more than 3 modes

When more than 3 modes are enabled during installation, the user can change the third button to another mode not yet visible or active. By holding down the third mode button for more than 3 seconds, a popup window will appear with the other available modes to choose from. If nothing is chosen, the active mode will remain the same and the menu will disappear by itself after some time.

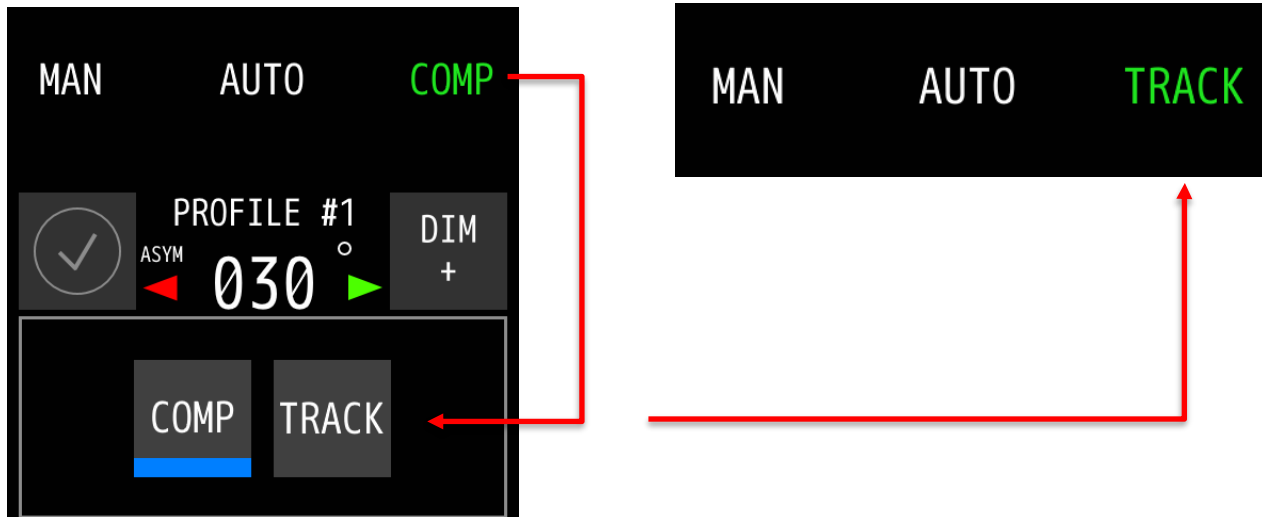

If a mode not yet selected or visible is chosen, that mode will become active/green and will replace the mode on the third button with this new chosen mode. This new mode is also remembered during normal switching between the 3 shown modes.

3.8 SLAVE

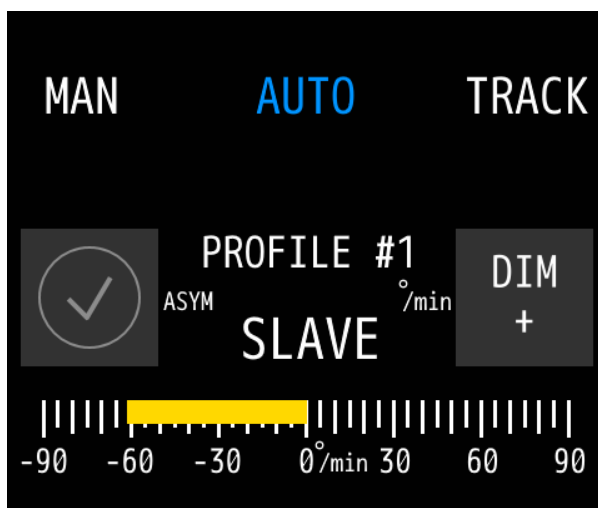

This mode can be enabled when connecting a second pilot for a master/slave combination, in case the ship has two (or more) sets of rudders. If asymmetrical steering is wished for, a separate Master/Slave button per pilot and a minimum of 2 MFS units are also required.

The settings for asymmetrical (indicated by ASYM on screen) steering is currently only possible by an engineer during installation and can only be changed by an engineer afterwards.

Slave will always show the mode selected by the master in blue.

3.9 Profiles



Like the previous autopilot model, it is possible to setup different profiles. This pilot supports up to 3 profiles. The following settings are unique to each profile:

- Settings RUDDER, TRIM, DAMPING and SENS.
- Different autopilot steering settings such as empty cargo, fully loaded, pushbarge with- and without bare.

Only during installation can the profiles and their naming be enabled. The list of names can be found on page 43, appendix C.

The profiles can be selected in the menu, under the SHIP CONFIG button.

3.10 Inactive MFS Tiller

When a minimum of 2 MFS tillers are connected on one pilot and the pilot is not in standby mode, the in-use tiller will be distinguished by the **green** mode text. This is the indication for the user that this tiller is now the main tiller. The other MFS that is not-in-use will show the active mode in **blue** and will show a screen similar to the SLAVE mode, showing no numbers, only feedback information.

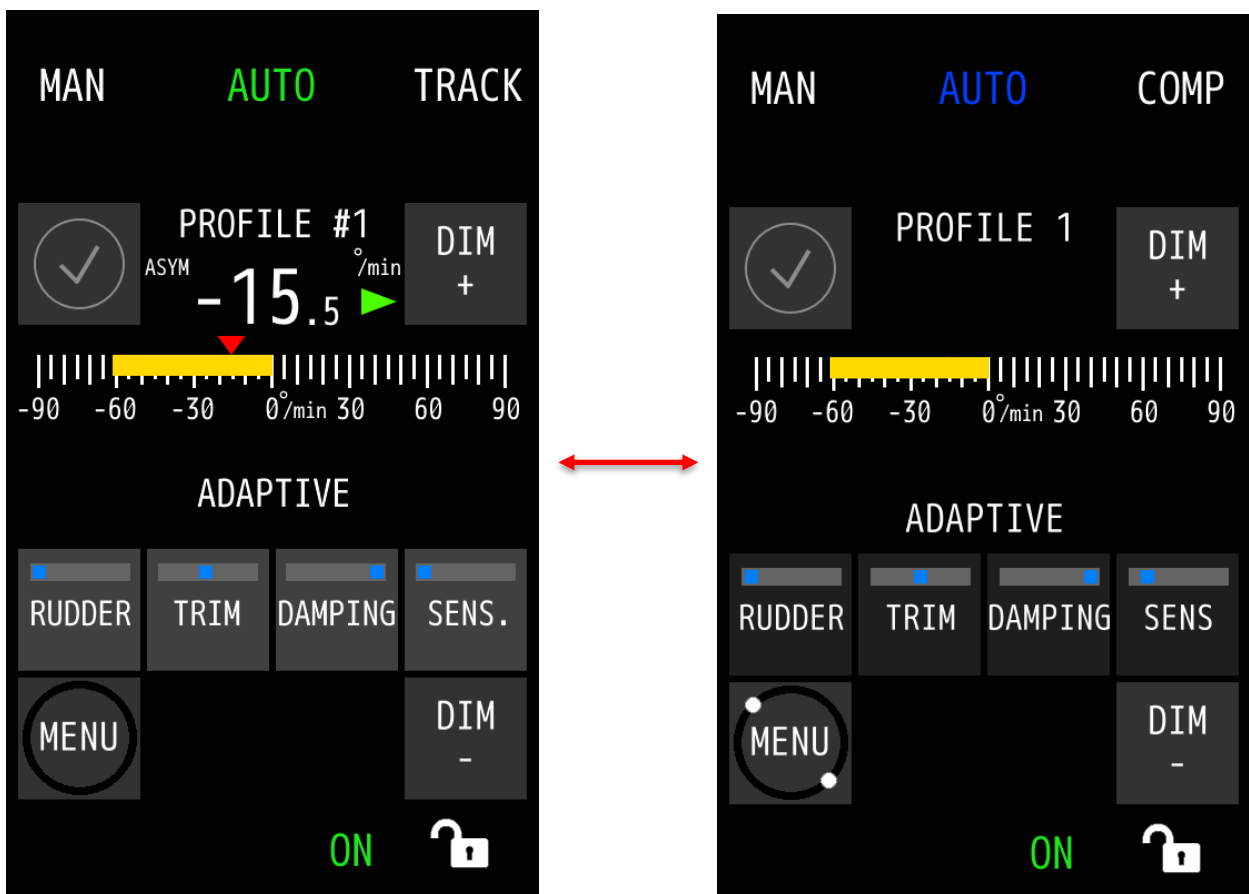

When the user wants to use the not-in-use tiller as the main tiller, one press on any mode will switch the **blue** tiller to a **green** tiller and the other tiller(s) to **blue**.

3.11 Adaptive Pilot

ADAPTIVE

This is a new functionality in the autopilot. When enabled, the pilot becomes self-learning and can self-adjust the settings for steering behavior.

- **RUDDER:** the autopilot will use the change in speed of the gyrotol to estimate the amount of rudder needed. When a quick change in rate of turn signal occurs, more counter rudder will be used to counteract.
- **TRIM:** whilst sailing, the autopilot can see if there is an offset needed to correct its trajectory. This can be measured during curves while not moving the tiller.
- **DAMPING:** the autopilot can detect oscillations on the rate of turn signal from the gyrotol sensor and add damping to the signal, allowing a smoother sailing experience.
- **SENS:** depending on the needed reaction speed of the rudders, this will be automatically de- or increased.

Example 1: the ship is sailing in a canal close to starboard. Many times the captain has to increase the rudder setting to increase counter rudder to prevent collision and straight sailing of the vessel. With the adaptive mode, the pilot will check the ROT signal and increase rudder and trim if necessary.

Example 2: the ship is unloaded and making a curve, but because of strong current and wind, the settings are not enough to make it and the captain will have to switch over to manual. Adaptive mode will automatically change the amount of rudder given during the curve to make sure the pilot will go to the asked ROT value while the tiller has not moved.

With the adaptive pilot mode on, the pilot will change settings in the background to allow for a smoother sailing and in turn use less fuel consumption. When disabling the adaptive mode, the default profile settings are used again.

The Adaptive mode can be enabled in the menu, under the SHIP CONFIG button (Chapter 5.1.2).

NOTE: *the adaptive mode will not remember any of its settings, because it will continue to adapt to new environments and so the settings are never the same.*

NOTE: *at the time of writing this manual, Adaptive sailing is still in its early release phase.*

3.12 Take-over contact (mode blocking)

When enabled during installation, the user can block mode switching on MFS units that are not the main controller. When pressing a mode button on a blue MFS, while the external takeover switch is enabled, 3 short beeps are heard, indicating the switching of modes are blocked and the user cannot takeover with a blue MFS.

4 Controls and functions

This section describes other controls and functions (not related to operating modes as described in the previous section).

4.1 Turn on

To turn on the MFS Control Unit, push the ON/OFF button.

The MFS Control Unit will start-up and after a first time start-up, the MFS Control Unit will go into Standby mode (the autopilot is not steering in this mode).

If an extra MFS Control Unit is powered on while the pilot is already on, then the MFS will automatically switch to the activate mode as a unused tiller unit.

If use of a standby contact is used, then depending on the setup of the pilot, the MFS will first go to Standby and when the contact is switched again, go to the pre-installed mode and profile. This is setup during installation.

4.2 Turn off

To turn off the MFS Control Unit, push and hold the ON/OFF button. This will NOT power down the processor box. The power for the pilot can only be removed by the use of external fuses.

4.3 Dimming

The **DIM -** and **DIM +** buttons are dimmed to a pre-set brightness level. Main control is on the **green** MFS Control Unit and **blue** MFS tillers will dim to the same brightness level as the main control. It is also possible to dim the **blue** MFS units separately from the green MFS, but once the dimming on the **green** MFS is operated, it will supersede the current **blue** MFS dimming values.

It is also possible to connect the Alpatron Marine MFS/M/L -line to the pilot, allowing central dimming control on the **green** MFS Control Unit.

4.4 Alert handling

When an alert is activated, the corresponding alert icon will be showed to the operator. The alert icon will be shown in the upper left corner of the display with the corresponding optic and acoustic signals:

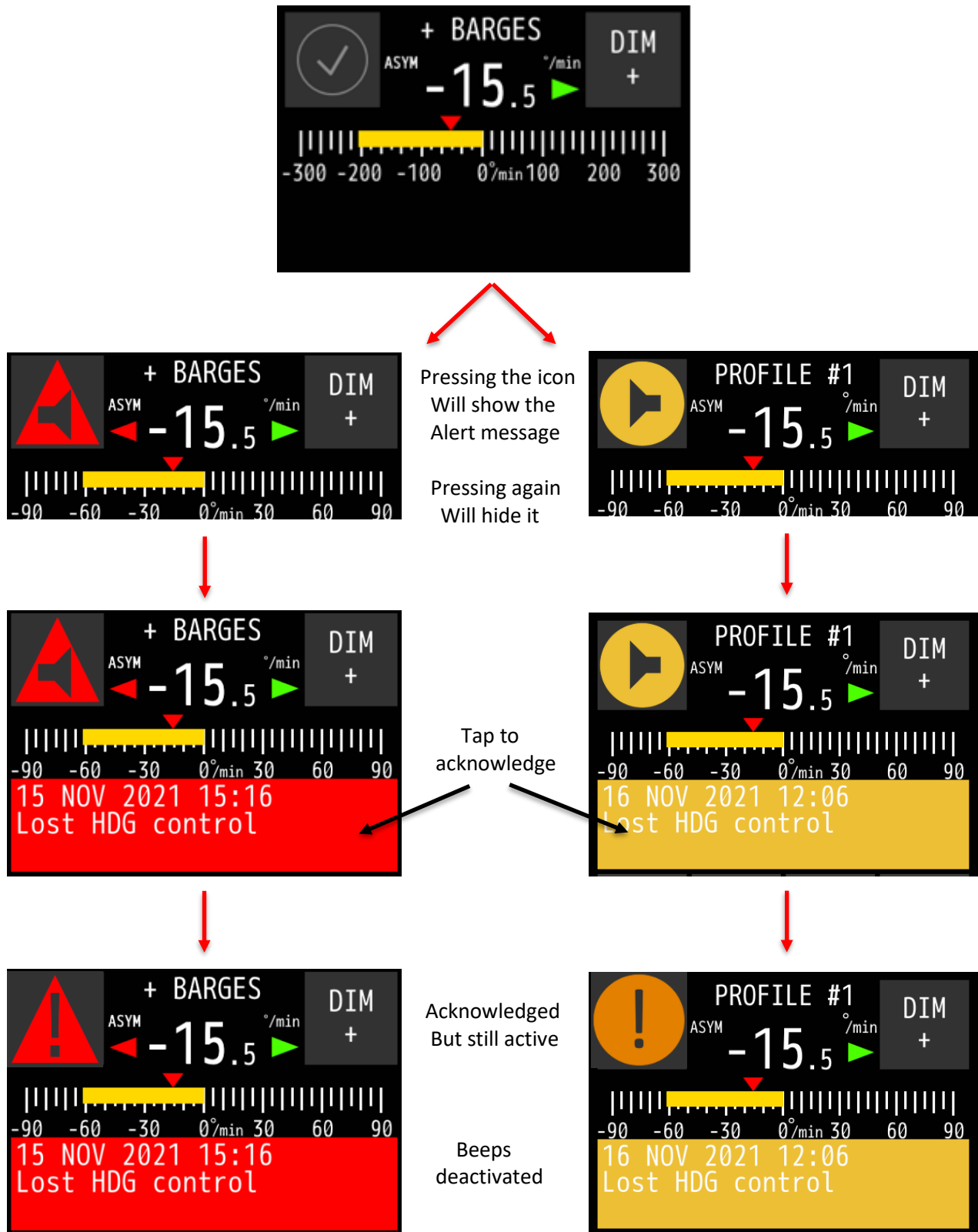

In case of multiple active alerts, the alert icon only shows the highest priority alert. But when acknowledging the alerts, the user can see the active alerts one by one.

If the alerts have not been acknowledged, but are also not active anymore, a “V” mark will appear. Tapping the alert message bar will remove the alert. If an SD-card is installed, all alerts can be logged (depending on the settings setup during installation).

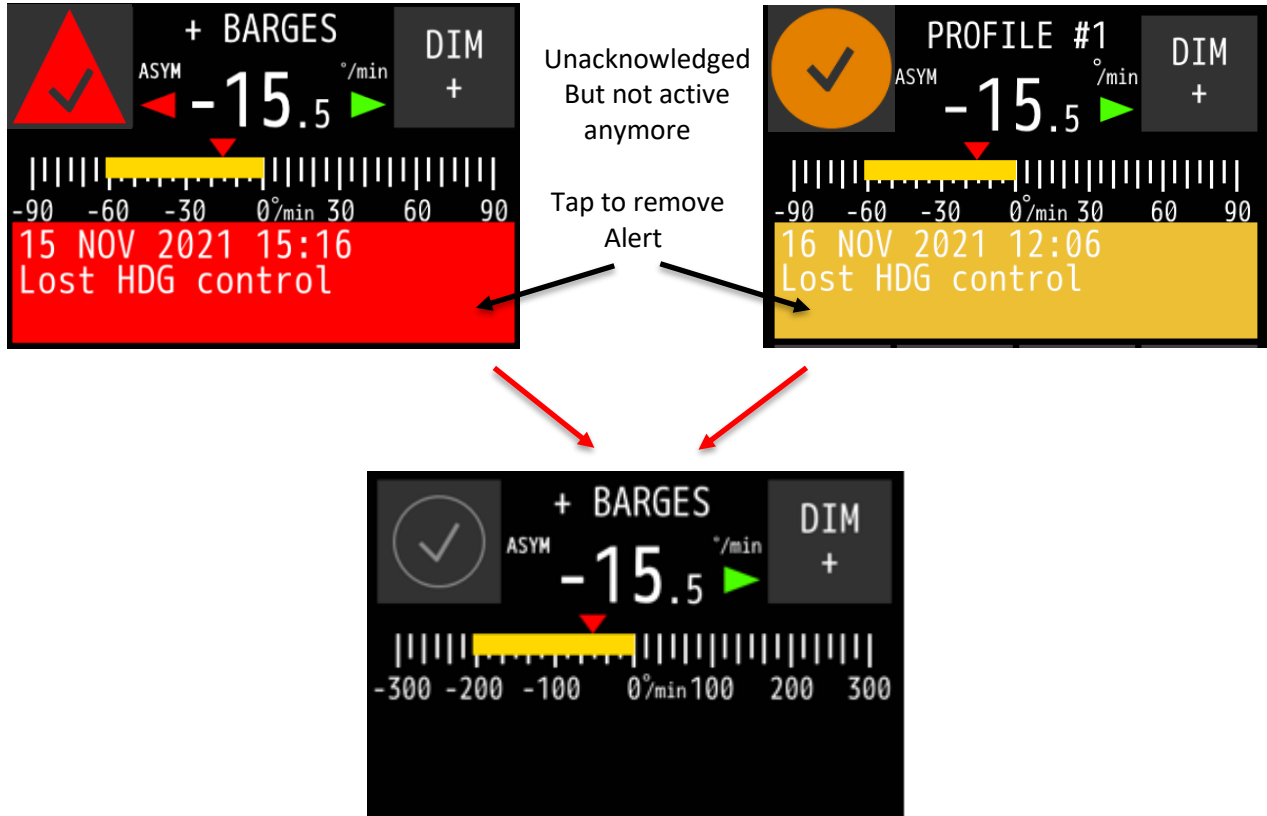

On the blue MFS tiller units the alerts are visible, but muted. This is indicated with the alert icons:



The muted alerts have the same mechanism described as above.

The following alert indicators are applicable:











Symbol	Symbol behaviour	Audible signal	Status	Priority	
	Flashing	Three long audible signals, repeated within every 10 s	Alarm active, not acknowledged	High	
	Flashing	Silent	Alarm active, silenced	↑ ↓	
	Flashing	Two short audible signal, repeated within every 5 min or replaced by an alarm	Warnings active, not acknowledged		
	Flashing	Silent	Warnings active, silenced		
	Steadily shown	Silent	Rectified — unacknowledged alarm		
	Steadily shown	Silent	Rectified — unacknowledged warning		
	Steadily shown	Suppression of audible signal (Silent)	Alarm active, acknowledged		
	Steadily shown	Silent	Warnings active, acknowledged		
	Steadily shown	Silent	Caution active		Low
	Steadily shown	Silent	Normal state		Not applicable

Table 4: Alert indicators

For a list of alerts, please see appendix D

5 Menus

The AlphaRiverPilot MFS has generic and advanced settings. All users are authorized to use the generic settings. Only a commissioning engineer has access to the advanced settings (ADV SET and PILOT SET button), which are only needed during commissioning or troubleshooting.

All menu items are explained in the following subsections.

Press the ← button to go back to the previous screen. Press the ACCEPT button to save a change. Press the DISCARD button to discard changes. Parameters can be adjusted with the + and - buttons.

MENU	SHIP CONFIG (PROFILE)	
	ADAPT MODE	
	USER SET	TOUCH CAL
		CLEAN MODE
		THEME
		DATE TIME
		ABOUT
		LOCK SCREEN
	ADV SET	[PASSWORD PROTECTED]
	REMOTE ACCESS	
	PILOT SET	[PASSWORD PROTECTED]

5.1 Menu 'Main Menu'

This menu is primarily used to quickly change settings during operation.

To enter the main menu, single press the MENU button.

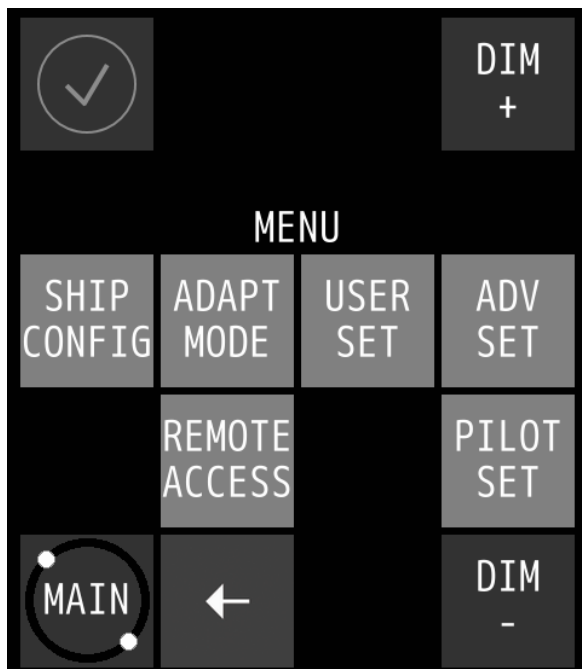

to accept or discard changes in the menu, use the “V” or “X” button respectively:



Menu Item	Description
SHIP CONFIG	Profile selection for autopilot.
ADAPT MODE	Menu to turn the adaptive mode on or off.
USER SET → TOUCH CAL	To calibrate the touch screen.
USER SET → CLEAN MODE	To clean the surface of the touch screen without accidentally activating a function.
USER SET → THEME	To change contrast brightness (i.e. illumination) and to set the language.
USER SET → DATE TIME	To change the date and/or time (on MFS only).
USER SET → ABOUT	The show the name and version of the software and when it was built.
USER SET → LOCK SCREEN	Settings such as automatic locking of the screen and timing.
ADV SET	To change Advanced settings of the MFS Control Unit. Only a commissioning engineer has access to the Advanced settings, which are only needed during commissioning or troubleshooting. Password protected.
REMOTE ACCESS	Opening or closing the firewall for changes from outside the AlphaRiverPilot MFS.
PILOT SET	To change Advanced settings of the MFS Control Unit. Only a commissioning engineer has access to the Advanced settings, which are only needed during commissioning or troubleshooting. Password protected.

5.1.1 Ship Config

The AlphaRiverPilot MFS is capable of saving user settings such as RUDDER, TRIM, DAMPING and SENS, and also autopilot configurations that are setup during installation.

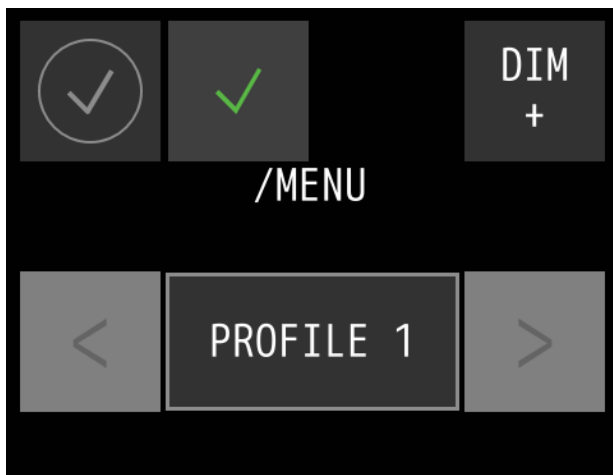

A maximum of 3 configurations is possible. The default names are named "Profile" with a number:

- Profile 1
- Profile 2
- Profile 3

5.1.2 Adapt Mode

This is a new functionality in the autopilot. When enabled, the pilot becomes self-learning and can self-adjust the settings for steering behavior. For an in-depth explanation, please refer to H3.11.

In the menu, adapt mode, the user can choose to enable or disable the adaptive mode. Once it is enabled, it will stay on in every mode.

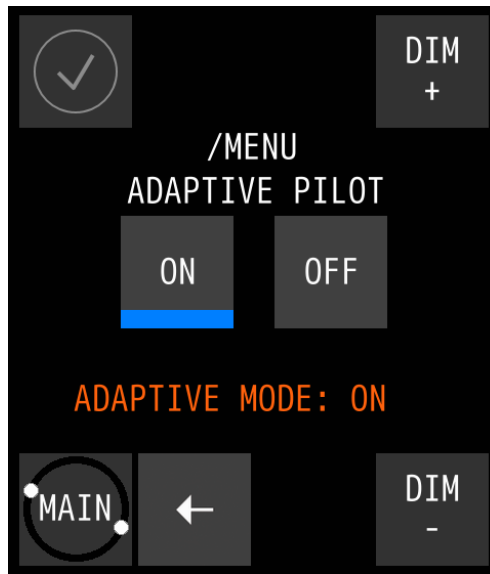
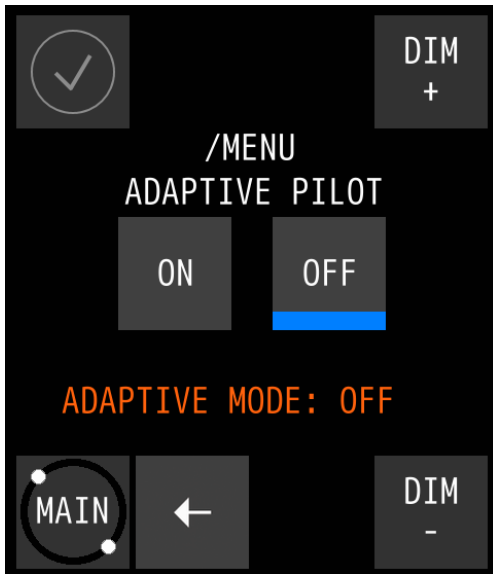

5.1.3 User Settings

This is a submenu for extra settings.

5.1.3.1 Touch screen calibration

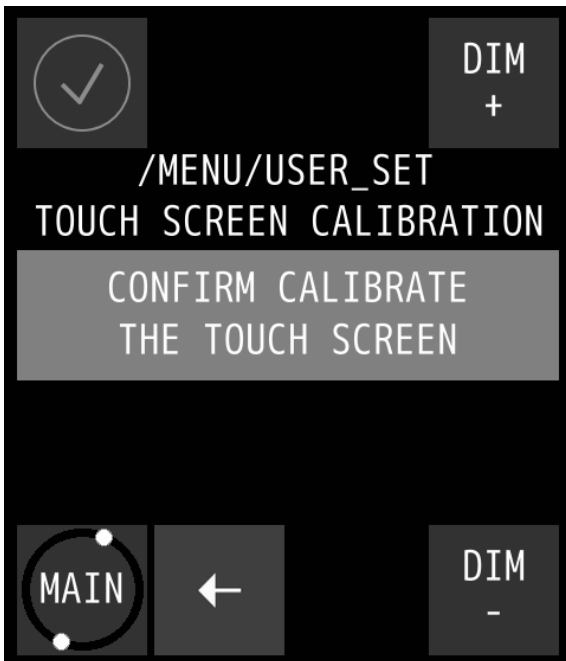

Calibrate the screen by performing the following procedure:

1. Press the **CONFIRM CALIBRATE THE TOUCH SCREEN** button.

The calibration screen appears with text requesting to touch the four numbered reference points that appear on the screen.

2. Touch the four reference points in sequence 1 to 4, as they light up.

The application will determine whether the sequence is carried out correctly. If the text **VALID CALIBRATION** appears, then the calibration is performed accurately.

3. Test calibration for accuracy by dragging a finger across the screen.

The line that appears on the screen should follow the finger.

4. Press the **ACCEPT** button if calibration is correct or touch the **AGAIN** button to repeat the calibration procedure.

If the text **INVALID CALIBRATION...PLEASE RETRY** appears, touch the **AGAIN** button to repeat the

calibration procedure.

5.1.3.2 Display cleaning

The purpose of the Clean Mode feature is to clean the surface of the touch screen without accidentally activating a function.

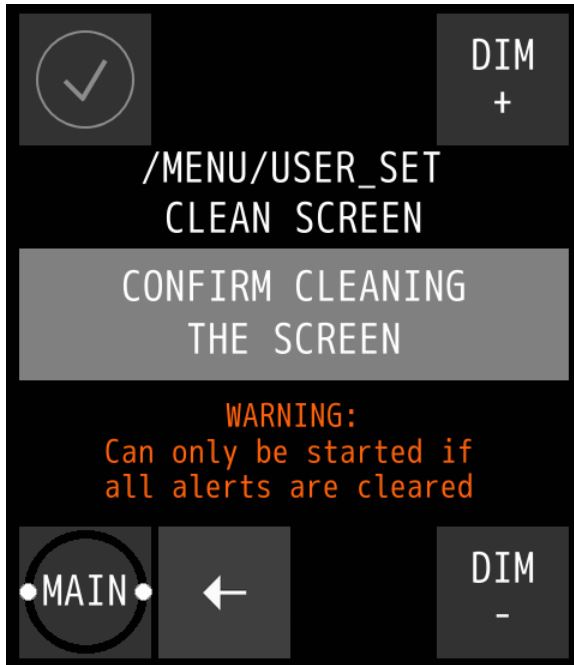

When the Clean mode is started, the touch screen will be deactivated for 60 seconds. Within this period the instrument will remain functional, but it is not operable.

Except when an indication is activated, then the touch screen will be activated immediately, and the instrument will be operable again.

To start Clean Mode, perform the following procedure:

1. Press the **CONFIRM CLEANING THE SCREEN** button to start the Clean Mode.
2. The AlphaPilot MFS Control Unit starts the countdown sequence. The touch screen is now deactivated, and the surface can be cleaned. After 60 seconds, or at an active alert, the instrument will become operable again.

NOTICE For safety reason, if an alert is active and needs attention of the operator, Clean Mode cannot be started.

5.1.3.3 Theme

Contrast brightness can be easily adjusted to Day, Dusk and Night settings, and language can also be changed in this menu.



To change the contrast brightness, perform the following procedure:

1. Press the + or – button to select the desired **ILLUMINATION** pre-set.

Three different illumination pre-sets can be selected, in accordance with ambient light: DAY, DUSK and NIGHT.

NOTE: the pre-sets are individual MFS settings and will not be used by other MF instruments.

2. Press the **ACCEPT** button to confirm the chosen settings.

To change the language of the Pilot, perform the following procedure:

1. Press the + or – button to select the desired **LANGUAGE** value.

Three different languages can be selected, Dutch, English or German.

NOTE: the language can only be changed on the **green** MFS. Other MFS Tiller units will also change language.

2. Press the **ACCEPT** button to confirm the chosen settings.

5.1.3.4 Date Time

To change the date and/or time, perform the following procedure:

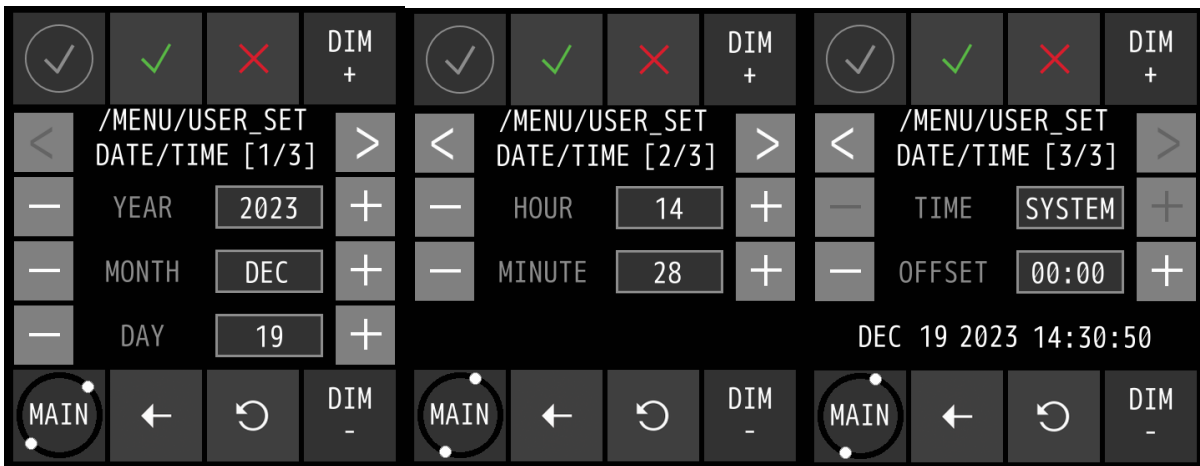

1. Press the + and/or – button to set the correct DATE values.
2. Press the > button to select the TIME screen.
3. Press the + and/or – button to set the correct TIME values.
4. Press the ACCEPT button to confirm the chosen values and return to the Main Menu.
5. To abort, press the ← button to return to the Main Menu.

5.1.3.5 About

The About screen contains the versions of the MFS Tiller and RiverPilot software and when it was built. It also provides extra information for the service engineer to troubleshoot the system.

MF ver.: = the installed MFS software on the tiller unit

MF bld: = creation date of the MFS software on the tiller unit

BL ver.: = the installed bootloader version on the tiller unit

MF bld: = creation date of the bootloader version on the tiller unit

Proc. Ver.: = processor software version (Processor Box)

Error Code: = these are numbers that can be used by the engineer to troubleshoot the system

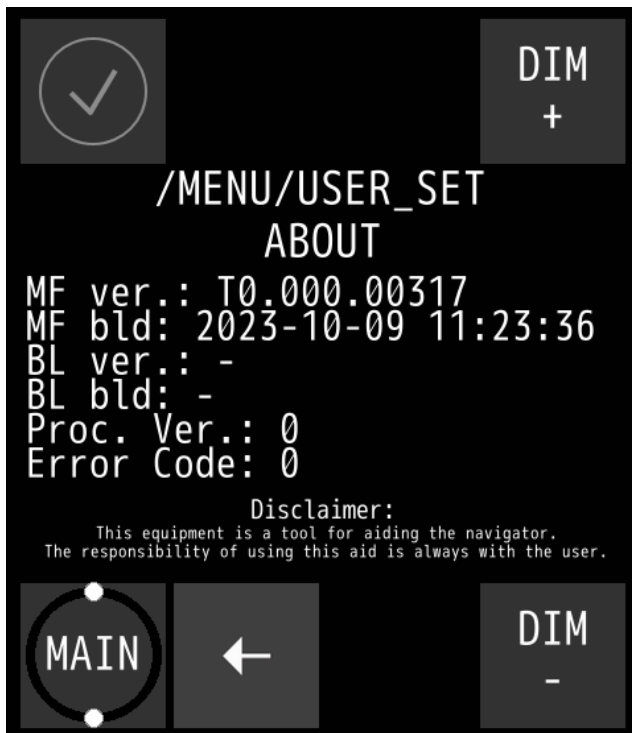

NOTICE When asking for support, this information will be useful.

5.1.3.6 Lock Screen

The MFS has the option to prevent user interaction with the screen, with exception of the 3 modes buttons at the top as these are always available for safety. This could prove useful when steering the autopilot and the user accidentally touches the settings on the screen. The button to un/lock the screen is located on the bottom right of the screen.



locked



unlocked

When pressing the locked icon for more than 2 seconds, the touchscreen is unlocked. The message “UNLOCKED” will be shown + 1 second beep. Message will disappear after 3 seconds. Once unlocked, the unlocked icon is shown.

The user can lock the touchscreen by pressing the icon for more than 2 seconds again or if auto-lock is enabled, press nothing on the screen for a period of time.

The message “LOCKED” will be shown + 1 second beep. Message will disappear after 3 seconds.

The autolock will display a warning message saying: SCREEN LOCKING IN 5 SECONDS, PRESS TO CANCEL. This is shown for all auto lock times when 5 seconds remain. Message will automatically disappear.

The user can cancel the auto locking by interacting with the screen. The internal timer will reset and the message will be shown again after some time.

When the user interacts with the screen when it is locked, the message “SCREEN LOCKED” is shown for + 2 short beeps.

Note: messages shown are translated as well

An auto-lock option is available in /menu/user set/lock screen

The user can turn off locking entirely in the menu. The main screen will not show any locking icons.

Options available:

- Off
- On (no auto lock and starts in unlocked mode)
- Auto lock 10s
- Auto lock 30s
- Auto lock 60s
- Auto lock 5min

5.1.4 Adv Set

To change Advanced settings of the MFS Control Unit. Only a commissioning engineer has access to the Advanced settings, which are only needed during commissioning or troubleshooting.

5.1.5 Remote Access

This menu option is used by the operator to allow external access to the AlphaRiverPilot MFS system. Another name would be the “firewall”.

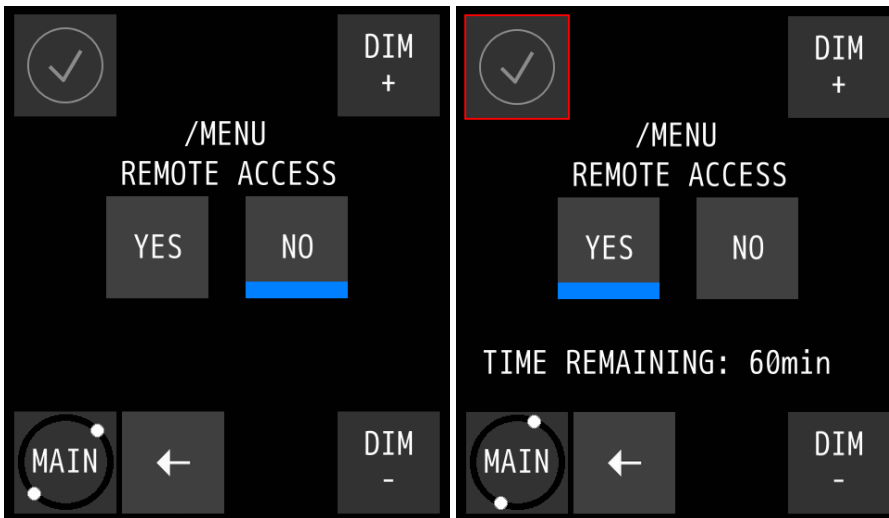

When YES is pressed, the blue line at the bottom of the button shows the button is pressed and the text: TIME REMAINING: ...min appears + a red square around the alert icon at the top left is shown, indicating that the “firewall” is open and changes from outside the pilot box can be made to the pilot.

5.1.6 Pilot Set

To change Advanced settings of the AlphaRiverPilot MFS system. Only a commissioning engineer has access to the Pilot settings, which are only needed during commissioning or troubleshooting.



Appendices



Appendix A: Specification - AlphaRiverPilot MFS

Power Supply Voltage:	18V – 32VDC
Only AlphaRiverPilot:	150mA
AlphaRiverPilot + 1 MFS:	325mA
AlphaRiverPilot + 2 MFS:	550mA
AlphaRiverPilot + 3 MFS:	775mA
AlphaRiverPilot + 4 MFS:	1A
AlphaRiverPilot + 4 MFS + valves:	5A

Appendix B: Mechanical drawings - AlphaRiverPilot MFS

AlphaRiverPilot MFS -V

G-009682 Weight 1,06 kg (2,34 lbs)

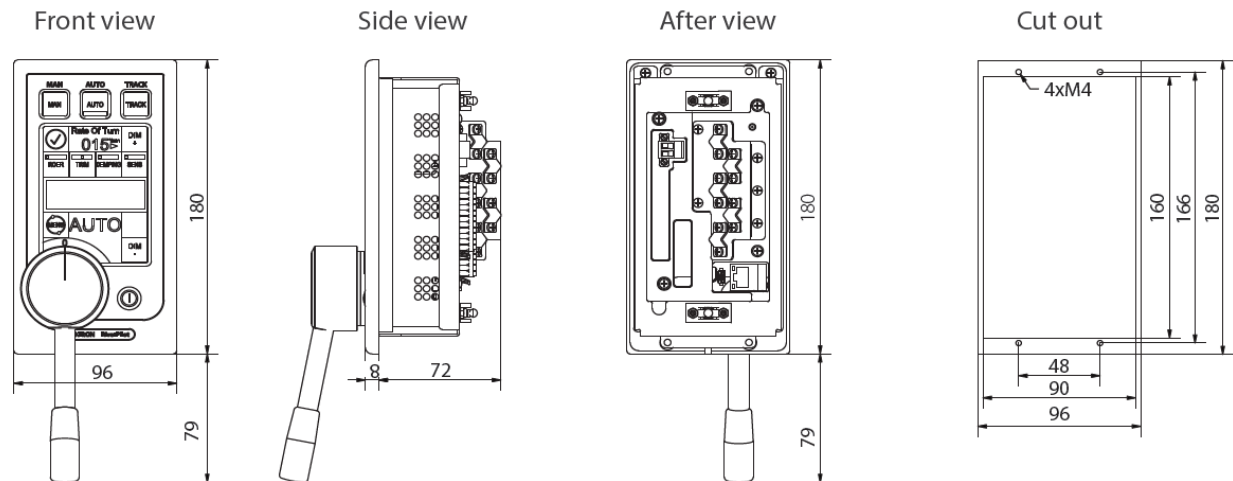

AlphaRiverPilot MFS (flush mounted) -VF

G-020220 Weight 1,06 kg (2,34 lbs)

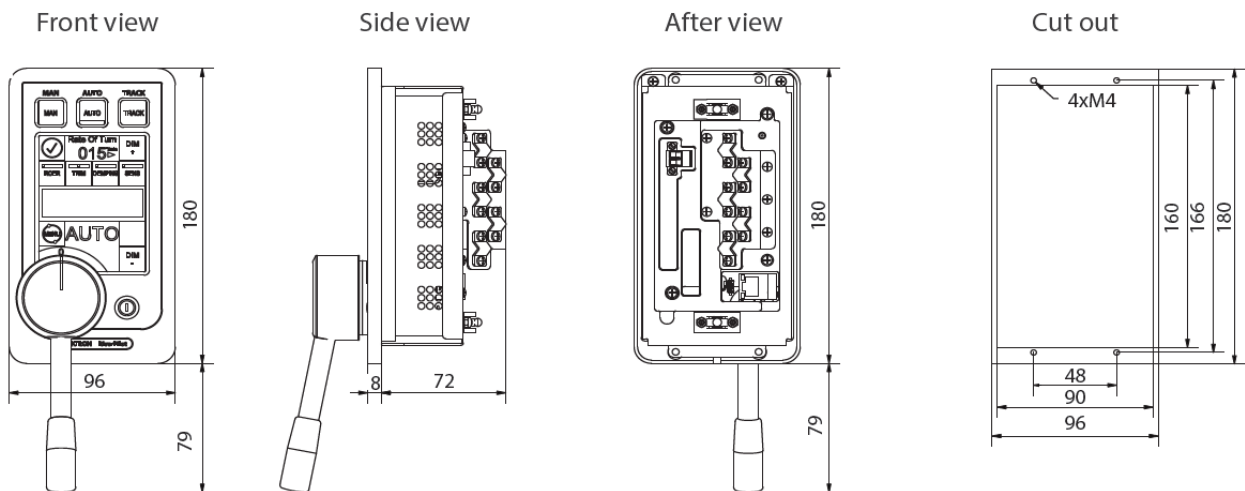

Processor box

G-020502 Weight 1,76 kg (3,88 lbs)

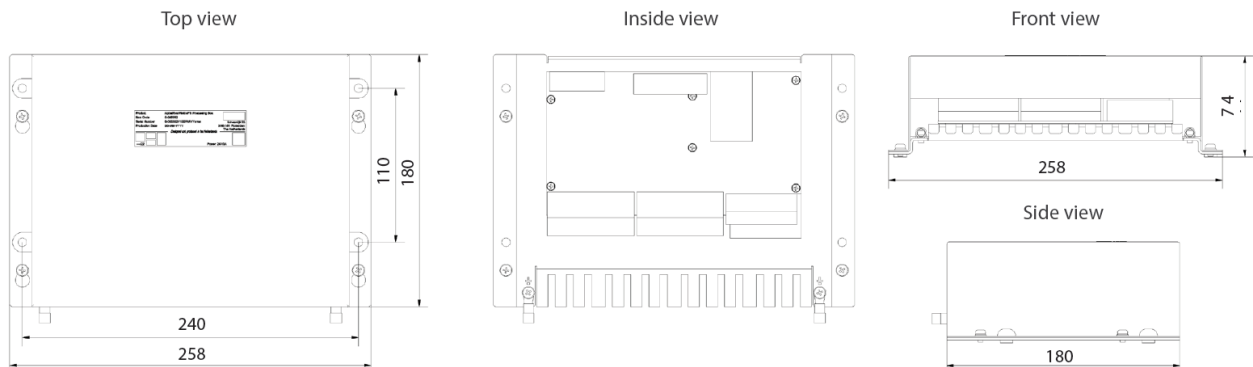

Adapterplate surface mounted - MFM to MFS-V

G-022114 Weight 0,24 kg (0,53 lbs)

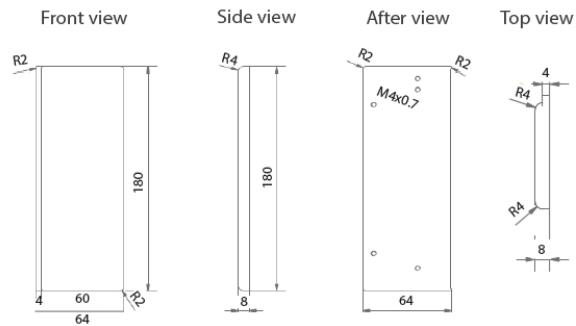

Adapterplate flush mounted - MFM to MFS-VF

G-022113 Weight 0,24 kg (0,53 lbs)

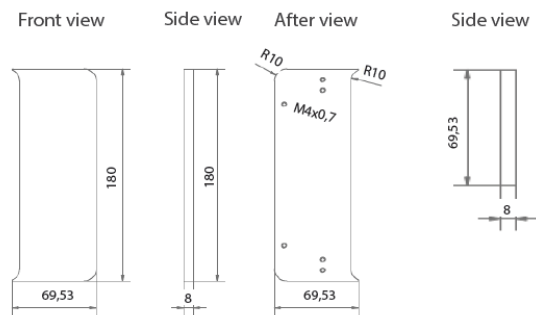

Adapterplate flush mounted wide - Sigma to MFS-VF

G-022776

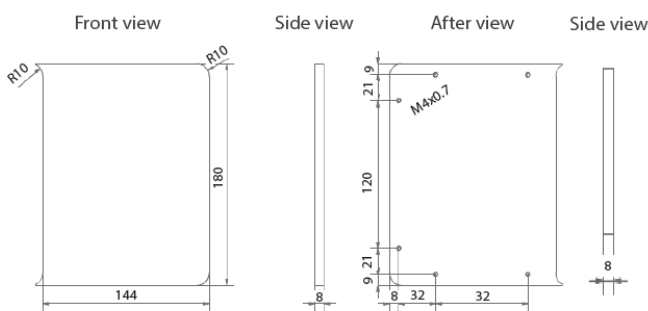

Adapterplate flush mounted- Sigma to MFS-VF

G-022775 (2 needed)

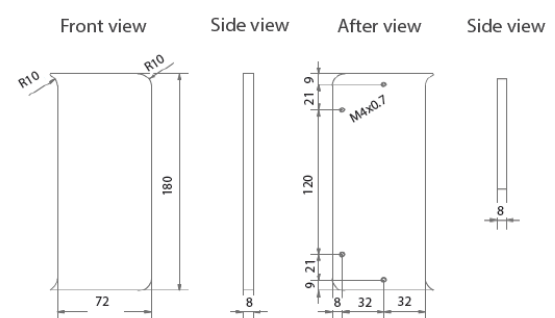

Appendix C: AlphaRiverPilot MFS Mode buttons + Profile name table

ENGLISH [EN]	GERMAN [DE]	DUTCH [NL]
FU	WEG	WEG
MAN	WEG	WEG
WEG	WEG	WEG
MAN	MAN	MAN
FAST	FLOTT	SNEL
FAST	SCHNEL	SNEL
AUTO	AUTO	AUTO
PILOT	PILOT	PILOOT
COMP	KOMP	KOMP
COMP2	KOMP2	KOMP2
COMP-R	KOMP-R	KOMP-R
TRACK	TRACK	TRACK
RMS	RMS	RMS
SLOW	LANGSAM	LANGZAAM
COMP-	KOMP-	KOMP-
COMP+	KOMP+	KOMP+
NORMAL	NORMAL	NORMAAL
PUSHER	SCHIEBER	DUWBOOT
LOADED	GELADEN	GELADEN
EMPTY	LEER	LEEG
PROFILE 1	PROFIL 1	PROFIEL 1
PROFILE 2	PROFIL 2	PROFIEL 2
PROFILE 3	PROFIL 3	PROFIEL 3
+ BARGE	+ LASTKAHN	+ BAK
+ BARGES	+ LASTKÄHNE	+ BAKKEN
AUTO + BARGE	A + LASTKAHN	AUTO + BAK
AUTO + BARGES	A + LASTKÄHNE	AUTO + BAKKEN
COMP + BARGE	K + LASTKAHN	KOMP + BAK
COMP + BARGES	K + LASTKÄHNE	KOMP + BAKKEN
TRACK + BARGE	T + LASTKAHN	TRACK + BAK
TRCK + BARGES	T + LASTKÄHNE	TRCK + BAKKEN
COMP + ROT	KOMPASS + ROT	KOMPAS + ROT
COMP - ROT	KOMPASS - ROT	KOMPAS - ROT
NO ROT	KEINE ROT	GEEN ROT
MASTER	MASTER	MASTER
SLAVE	SLAVE	SLAVE
COMPASS	KOMPASS	KOMPAS
RMS STEERING	RMS STEUERUNG	RMS BESTURING
RMS ONLY	NUR RMS	ALLEEN RMS
+ RMS	+ RMS	+ RMS

Appendix D: Alpatron MFS Alerts

ALARMS:

COURSE ALARM	The wanted course is not reached within a certain amount of time. Possible solution is to use more RUDDER.
RUDDER ALARM	The speed of the rudder is below 1 degree per second or cannot reach the wanted position. Please check the steering system.
SECOND RUDDER ALARM	the same alarm as rudder alarm, but for the second steering system.
RATE OF TURN ALARM	Alarm from the rate of turn. Please Check the rate of turn system and don't sail on auto mode.
MAIN PILOT POWER SUPPLY ALARM	Voltage level for power supply 1 is incorrect. Please check the external fuse.
SECOND PILOT POWER SUPPLY ALARM	Voltage level for power supply 2 is incorrect. Please check the external fuse.
INTERNAL PILOT POWER VOLTAGES ALARM	Voltage level is incorrect. Please contact Alpatron Marine.
RUDDER POWER SUPPLY ALARM	Voltage level for power supply 3 is incorrect. Please check the external fuse.
EXTENSIONBOARD POWER SUPPLY ALARM	Voltage level for the extension board is incorrect, please contact Alpatron Marine.
TRACKPILOT ALARM	Please check the TrackPilot system for the specific alarm.
COMPASS ALARM	Please check the Compass system.
THRUSTER ALARM	Please check the thruster system.
DEADMAN ALARM	Deadman has not been reset by user in time.
MANUAL OVERRIDE	Autopilot switches automatically to Follow Up mode if max tiller position has been reached.
MASTER-SLAVE CONTROL LOST	The autopilots have failed communication. Please contact Alpatron Marine.
MAIN CONTROL LOST	The green MFS has no connection to the pilot, please take-over control on the blue MFS.
TRACKPILOT DISABLED	When moving the tiller out of the zero and depending on settings, the pilot switches the mode from TRACK to FU or AUTO mode.
BATTERY DEAD	The voltage of the battery is too low to function and needs replacement. The battery is only used for date/time for alarm logging on sd-card. Settings are not forgotten.
PILOT TEMPERATURE TOO HIGH	The measured temperature of the main controller is dangerously high, please contact Alpatron Marine.

WARNINGS:

ROT MISMATCH WARNING	Indicates that the digital gyro is running on a different range, please contact Alpatron Marine.
TRACKPILOT NOT READY	Shown when switching to track mode, but the system is not ready. Please check the settings of the trackpilot.
COMPASS NOT READY	Shown when switching to compass mode, but the system is not ready. Please check the settings of the compass.
DEADMAN WARNING	When the set time for the deadman warning has passed, an alert is given.
PILOT TEMPERATURE TOO HIGH	The measured temperature of the main controller is too high, please contact Alpatron Marine.
WARNING AUTO STILL ACTIVE	When the tiller is on maximum command while in auto mode, the pilot can give an warning that the pilot is still in auto mode. Warning is reset when moving away from the endpoints.
CALIBRATION MODE, TILLER CAN CANCEL	During installation of the AlphaRiverPilot MFS, the engineer can start calibrations. This warning indicates that + moving the tiller can interrupt the calibration.
BLUE MFS TILLER LOST CONNECTION	The green MFS can give an warning that a blue MFS controller unit has lost connection to the pilot. Please check the connections or call Alpatron Marine.